

CEMETERY REGULATIONS

Effective December 1, 2022

South Hill Cemetery



City of
Prince Albert

CITY OF PRINCE ALBERT

Schedule of Cemetery Fees Commencing on January 1, 2024

All fees within this schedule are subject to change to reflect current costs and tenders with the approval of the Director of Parks, Recreation & Culture.

CEMETERY LICENSE FEES

Adult Traditional Plot.....	\$1,840.00
Children's Section Traditional Plot.....	\$ 920.00
Infant/Stillborn Plot.....	\$ 370.00 (for infants 1 week old or less)
Veteran's Section Traditional Plot**.....	\$1,375.00 (Subject to change. Includes Monument, Permit & Installation. GST exempt)
Double Depth Traditional Plot.....	\$2,045.00
Cremation Section Plot.....	\$ 920.00
Indigent Traditional/Cremation Plot.....	N/A (Pay Interment Fee & Other Fees without GST)
Columbaria Niche (upper 4 rows).....	\$2,575.00 (Includes first interment fee)
Columbaria Niche (bottom row).....	\$2,075.00 (Includes first interment fee)

INTERMENT FEES

Adult Traditional.....	\$1,035.00
Child Traditional.....	\$ 605.00
Infant/Stillborn Traditional.....	\$ 305.00
Double Depth Traditional.....	\$1,100.00
Cremation (In-ground).....	\$ 305.00
Columbaria Niche.....	1 st interment included in License Fee
Columbaria Niche Additional Open/Close.....	\$ 40.00 (for openings other than 1 st interments)
St. Mary's Cemetery (Emergency Only).....	Current Interment Fee + 15%

DISINTERMENT FEES

Traditional.....	\$1,840.00
Cremation (In-ground).....	\$ 860.00
Columbaria Niche.....	\$ 40.00

Note: Disinterment will only be provided from May 1 to October 31 of each year.

OTHER FEES

Winter Fee (November 1 st to April 30 th).....	\$ 140.00
Short Notice Booking Fee.....	\$ 240.00
Short Notice Cancellation Fee.....	Cost Recovery + 15%
City Supplied Fibreglass Vault**.....	\$ 620.00
Vault Handling.....	\$ 160.00 (applies to non-City supplied vaults)
Monument Permit.....	\$ 110.00
Monument Permit - Indigent Plot / Common Plot.....	\$ 110.00 + 15% of Current License Fee
Administration Fee for Transfer / Sale of License.....	\$ 50.00
Perpetual Care Fee on licenses purchased after January 1, 2020.....	\$ 200.00
Perpetual Care Fee for subsequent burials.....	\$ 100.00

WEEKEND/HOLIDAY & OVERTIME FEES

Saturday (only available between 9:00am & 12:00pm).....	\$ 545.00
Sunday, & Public, Civic & Union Holidays.....	\$1,635.00 (On emergency basis only)
Overtime**.....	\$ 140.00 per ½ hr

*Overtime is charged on weekdays after 4:30 p.m. and on Saturdays, Sundays, & Holidays for anything over a 2 hour call out.

**Indicates that the fee is subject to change based on the current Tender.

The rates listed in this Schedule of Cemetery Fees do not include any Goods and Services Tax (GST) that may be applicable.

CITY OF PRINCE ALBERT

Contact Information

Parks, Recreation & Culture Office - South Hill Cemetery Administration

Burial Bookings, General Inquiries, Plot Purchases, Cemetery Records & Monument Permits
3rd Floor, City Hall
1084 Central Avenue
Prince Albert, SK S6V 7P3
306-953-4800
306-953-4915 (Fax)
csd@citypa.com

South Hill Cemetery

On-site Assistance, Monument Install Bookings & Inspections, General Inquiries
135 Marquis Road West
Prince Albert, SK
306-953-4885
306-953-4915 (Fax)
csd@citypa.com

Hours of Operation

Parks, Recreation & Culture Office

Monday to Friday	8:00 a.m. to 4:45 p.m.
Saturday, Sunday & Designated Holidays	Closed

South Hill Cemetery Office

Monday to Friday	7:30 a.m. to 5:00 p.m.
Saturday, Sunday & Designated Holidays	Closed

Interment Hours

Monday to Friday	9:00 a.m. to 4:00 p.m.
Saturdays*	9:00 a.m. to 12:00 p.m.
Sunday & Designated Holidays*	Emergency Only

*Saturday interments will incur a Saturday Fee, and Sunday and Designated Holiday interments will incur a Sunday and Public, Civic, and Union Holiday Fee in accordance with the Schedule of Fees.

Disinterment Hours (May 1 to October 31)

Monday to Friday	9:00 a.m. to 4:00 p.m.
------------------	------------------------

Interments outside of these hours may be approved at the discretion of the Cemetery Foreman; however, additional fees shall apply as identified in the Schedule of Fees.

CITY OF PRINCE ALBERT

Cemetery Monument Specifications

1. Definitions

- (a) “Base” means the lower portion of a two-piece monument set on a foundation;
- (b) “Die” means the upper portion of a two-piece monument and the part of the monument that is placed on the base;
- (c) “Die without a base” means a monument consisting of a single piece placed on a foundation;
- (d) “DVA” means a Veteran’s monument;
- (e) “Fixture” means any item that is attached to a monument including vases, statues, pictures, lanterns, metal rods or similar items;
- (f) “Flat Marker” means a type of monument that has a flat and level surface upon which an inscription may be made or a bronze plaque affixed. They are either set flush with the ground or set upon a concrete or granite foundation;
- (g) “Foot Marker” means a monument that is placed at the foot of the grave;
- (h) “Foundation” means a pre-cast or poured-in-place pad, usually made of concrete, or a granite slab, set at grade, upon which a monument is placed;
- (i) “Headstone” means a monument that is placed at the head of the grave;
- (j) “Height” means the dimension of the Monument as measured from the top of the foundation to the top of the Die;
- (k) “Length” means the dimension of the monument as measured from the left edge to the right edge, including the foundation where applicable, facing the monument;
- (l) “Monument” means any structure in the Cemetery erected or constructed on any plot for memorial purposes;
- (m) “Monument Permit” means the official permit application provided by the City of Prince Albert Parks, Recreation & Culture Department for the request of a monument installation or removal;
- (n) “Pillow Monument” means a rectangular shaped monument where the back is slightly taller than the front creating a beveled face which is more visible than a flat monument;

- (o) "Upright Monument" means a monument projecting above the ground that is set upon a concrete or granite foundation;
- (p) "Width" means the dimension of the monument as measured from the front edge to the back edge, including the foundation where applicable, facing the monument.

2. **General Specifications**

- (a) A permit **MUST** be obtained from the City of Prince Albert, Parks, Recreation & Culture Department for each monument installation and/or removal; and such permit(s) must be submitted to the Cemetery Foreman **PRIOR** to proceeding with any work.
- (b) The following do not require an approved Monument Permit:
 - i. Minor monument additions or changes that do not affect the existing size or integrity of the monument, ie. Adding a vase or small bronze plaque to a base or foundation.
 - ii. Veteran's monuments as the Permit Fee is included in the License Fee and monuments are ordered internally by City staff at the time of interment or plot purchase through the City's contractor for Veteran's markers. The only exception would be monuments ordered by Veteran's Affairs or Last Post Fund. These would require a permit to be submitted by the organization.
 - iii. The engraving of any dates, words, etc being added to an existing monument.
 - iv. Niche door covers. The permit fee is included in the License Fee and the granite doors are provided by the City with the purchase of a niche; however all engraving is to be undertaken by a private contractor and done to City specifications.
- (c) All permit applications must be made on the prescribed forms available from the Parks, Recreation & Culture Office. Permit forms can be obtained in person or electronically from the Parks, Recreation & Culture Department at City Hall; or can be found on our website at www.citypa.com. A copy of the Monument Application Form is attached to these Regulations as Schedule "C".
- (d) Applications should be submitted to the Parks, Recreation & Culture Office. The payment of the Monument Permit Fee is due at the time the application is made, or within the time frame specified on an appropriate invoice. The Cemetery Foreman has the right to refuse the installation of any monument for which the permit fee has not yet been paid.
- (e) Once the monument has been installed, and the Cemetery Foreman has approved that the installation is to City standards, a copy of the permit shall be mailed to the applicant.
- (f) In cases where a double monument is requested to be placed, centered between two plots, the monument will be permitted to contain either one shared die, or two separate

dies; however, the two dies shall share a base and/or foundation which must still fall within the minimum and maximum sizes specified in the Regulations. Double monuments with two dies will require two monuments permits to be obtained and two monument fees to be paid, one for each die.

- (g) No monument shall be erected, altered or removed without approval from the Cemetery Foreman or designate. The City accepts no responsibility for any monument work initiated prior to the approval of a Monument Permit.
- (h) The Licensee or authorized decision-maker of a plot or plots shall be the authority with respect to the requested placement of a monument on said plot(s). Persons, other than the Licensee, who make application for the placement of a monument, do so at their own risk. The City does not accept any responsibility for resolving disputes between surviving family members or friends that may result from the placement of a monument.
- (i) All installations, removals, engraving, and adjustments are to be done by a licensed contractor that has experience with working with monuments. With the exception of the Veteran's Sections, the City does not provide any installation/removal, engraving or footing services.
- (j) Only monument work approved by an application submitted to the Parks, Recreation & Culture Department shall be carried out, and only during the normal hours of operation for the Parks, Recreation & Culture Office and Cemetery.
- (k) Any work to be carried out other than during normal scheduled hours of operation requires the approval of the Cemetery Foreman. Monument work performed outside of normal work hours will be inspected by the Cemetery Foreman upon their return, and if found to not be installed to City specifications, the monument will be removed by Cemetery Staff and the Contractor contacted to re-install. All costs of removal and re-installation are the responsibility of the Monument Permit Applicant and/or Contractor.
- (l) Any monument company employees, contracted employees or authorized individuals carrying out any monument work in the Cemetery, shall advise the Cemetery Foreman upon arrival at the Cemetery and shall be responsible for the restoration or repair of any damages to the Cemetery grounds or fixtures resulting from their actions.
- (m) The Cemetery Foreman shall schedule the timing of monument or foundation installations. These installations shall only take place between May 1 and October 1 of each year; installations not completed prior to the cut-off date shall be honored the following spring. Regardless, the installation of monuments and foundations for upright monuments shall not take place until the gravesite is suitably landscaped.
- (n) No Monuments shall be installed in the Cemetery until:

- i. The applicant has applied and paid for a Monument Permit and the said permit has been approved;
 - ii. In the case of monuments to be installed on a foundation, the Cemetery Foreman has confirmed that the foundation is complete. Please note, that due to other job duties, the Foreman may not be readily available to perform an inspection. In these circumstances, the Contractor may be asked to come back at a later date and/or time. To avoid any delays, we recommend that an inspection appointment be made with the Cemetery Foreman by calling the Cemetery Office at 306-953-4885 prior to the installation date.
 - iii. The Cemetery Foreman has confirmed that the gravesite has been landscaped.
- (o) Authorizations to drive a vehicle anywhere other than on designated roadway must be obtained from the Cemetery Foreman.
 - (p) The Cemetery Foreman shall determine specific locations for monument installation and no monument is to be installed prior to receiving such directive from the Cemetery Foreman.
 - (q) The Cemetery Foreman shall designate the place where materials to be used in connection with the installation of any monument are to be stored during the course of the installation.
 - (r) Failure to comply with any of these regulations may result in the removal of all or part of the said monument(s) by City forces without any obligation on the City to restore the same.
 - (s) No person shall place or erect in the Cemetery any monument or like structure that does not consist solely of imperishable and adamant materials. Monuments or any like structures, or applied decoration constructed of plastic, glass, perishable, or easily damaged materials are hereby prohibited in the cemetery.
 - (t) Marble, Limestone, Metal and Concrete monuments are not permitted.
 - (u) Foundations must be made of either granite or concrete with a minimum of 4,000 PSI.
 - (v) Monument bases must be constructed of granite only.
 - (w) No more than one headstone and one foot marker will be permitted on each plot with the exception of the Veteran's Section where foot markers are not permitted.
 - (x) Where a monument is to be erected or altered as a memorial to a person not interred in the Cemetery, the inscription must clearly indicate that no burial has taken place.

- (y) The City reserves the right to change the design of the Cemetery affecting the placement of existing and new monuments.
- (z) Monuments are placed in the Cemetery at the risk of the Licensee of the plot or of the permit applicant. The City accepts no responsibility for theft or damage resulting from vandalism or Acts of God.
- (aa) The City's maintenance of monuments shall be limited to keeping the ground in such condition that the monuments remain level and straight.
- (bb) The City accepts no responsibility for degrading of the monuments or markers due to normal wear or deterioration. Minor chipping of the base portion of the monuments caused by regular turf mowing operation is considered normal wear.
- (cc) All vases and statutes must be permanently affixed and positioned so that no part extends beyond the length or width of the foundation and/or base; nor extends above the total monument height. Only invertible turndown vases, which turn down and are made to place completely inside the monument are permitted on flat headstones, no vases are permitted on foot markers.
- (dd) No statues or fixtures other than approved bronze plaques and/or turndown vases shall be permitted on any flat monument.
- (ee) The Cemetery Foreman must approve fixtures or attachments to any monument.
- (ff) All back-to-back monument foundations shall be 24" x 48".
- (gg) The City may remove and dispose of any monument, memorial structure or fixture placed in the Cemetery if such should fall into disrepair or become unsightly. The City shall forward written notification, prior to undertaking this action, to the last known address of the Licensee of the plot or next-of-kin.
- (hh) All monuments must meet City specifications and Bylaw regulations.

3. Upright Monuments

- (a) Single piece upright monuments without a base – The die may be secured upon a minimum 4" deep foundation with a monument glue; or be recessed 4" or more into the foundation with the foundation being a minimum of 6" deep.

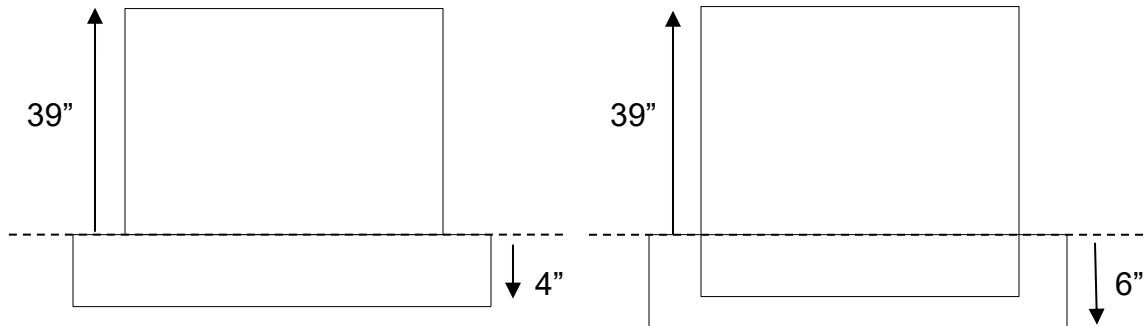

- (b) Two-piece upright monuments - The base may be recessed 2" into a minimum 4" foundation; or secured upon the foundation with monument glue. Foundations must be installed flush with the grade of the ground and protrude 4" from all sides of the base.

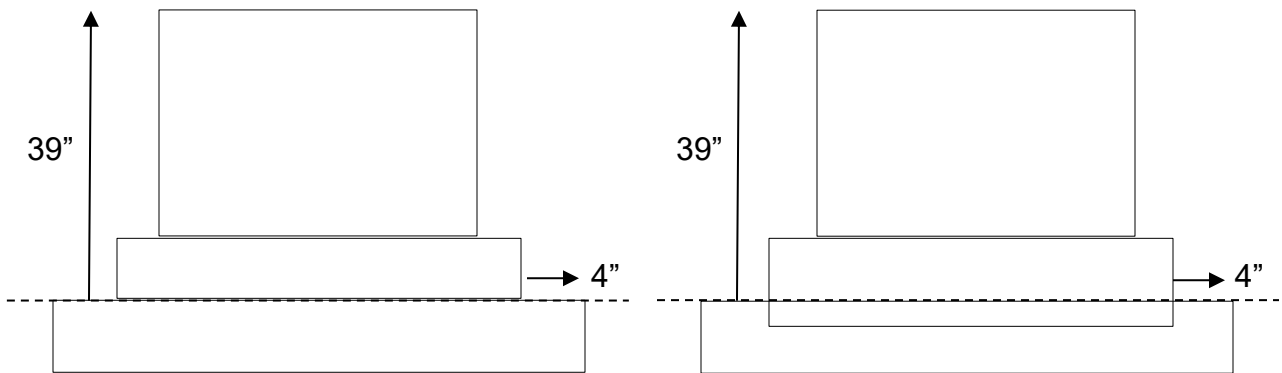

- (c) Two-piece double die monuments - The base may be recessed 2" into a minimum 4" foundation; or secured upon the foundation with monument glue. Foundations must be installed flush with the grade of the ground and protrude 4" from all sides of the base.

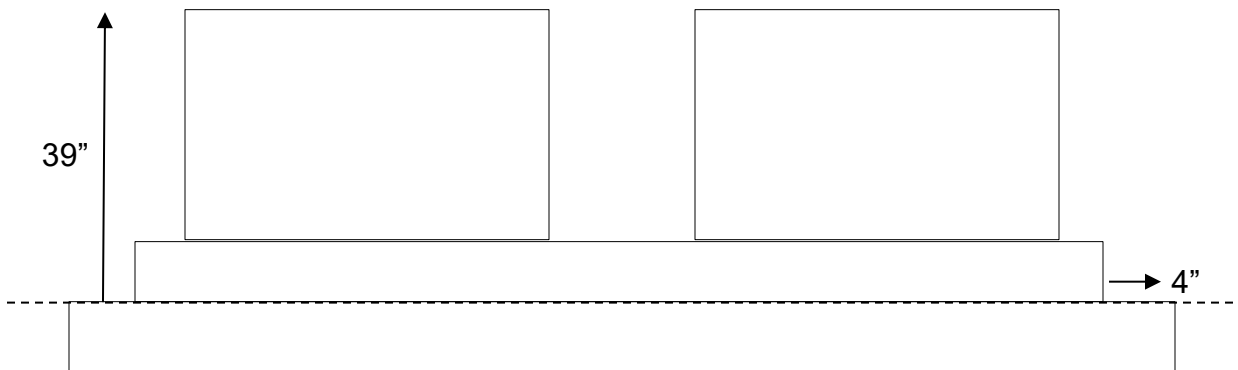

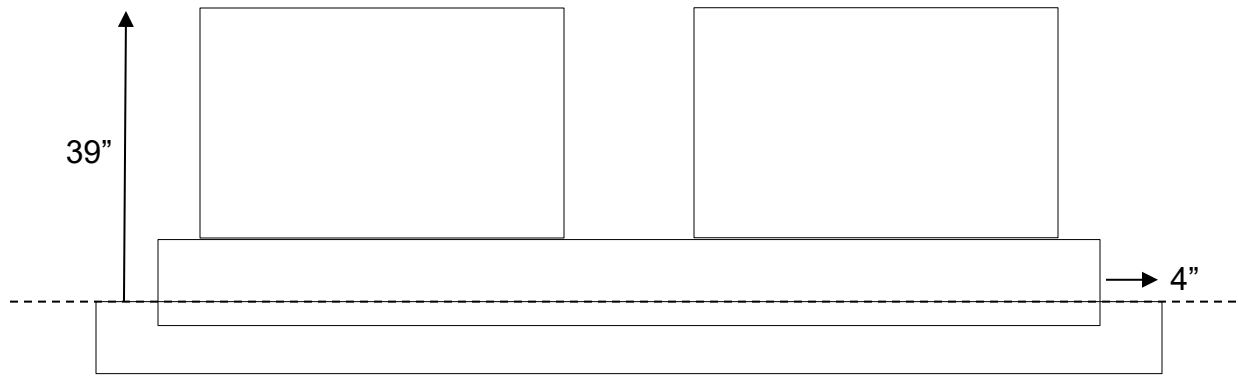

- (d) The City is not responsible for any failure or weakening of material used to secure a base or die.
- (e) Foundations shall be between 20" and 24" in width, and 24" and 48" in length for each lot, unless otherwise stated, and a minimum of 4" in thickness. Foundations shall be made of 4" thick precast concrete or granite, or poured in place concrete with a minimum thickness of 6". All foundations must be installed flush with the grade of the ground.
- (f) All upright monuments have a maximum height of 39" measured from the top of the foundation to the top of the monument.
- (g) The base of upright markers shall be between 12" and 16" in width, and 16" and 40" in length.
- (h) The Cemetery Foreman must be contacted to inspect all monuments including the base and foundation, BEFORE the monument is placed. Failure to have the Cemetery Foreman make this inspection could result in removal of the monument to allow an inspection to be made, and in such cases, re-installation of the monument shall be the responsibility of the owner or contractor.

4. Flat, Bronze & Pillow Monuments

(a) Bronze Monuments

- i. Bronze monuments - Shall be installed on a 4" thick granite foundation and secured with screws or monument glue. Foundations must be installed flush with the grade of the ground and protrude 2" from all sides of the base.

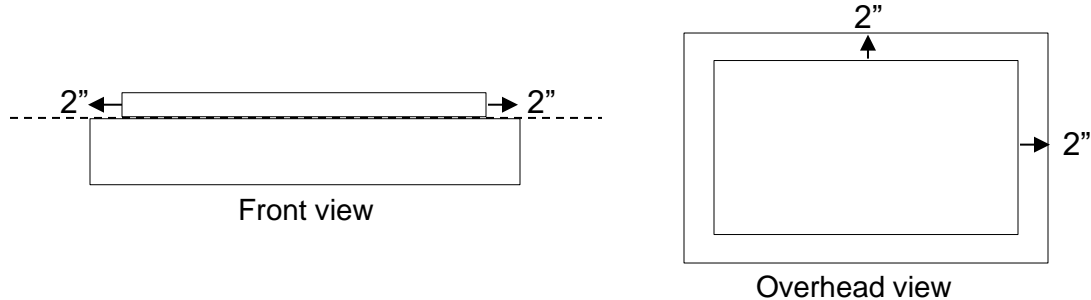

- ii. Bronze markers shall be between 16" and 20" in width and 20" and 44" in length.

(b) Flat Monuments

- i. Flat granite monuments installed flush with the grade of the ground - Shall be a minimum of 4" thick and be between 16" and 24" in width, and 24" and 48" in length. Flat flush monuments must be installed on 4" compacted sand base.

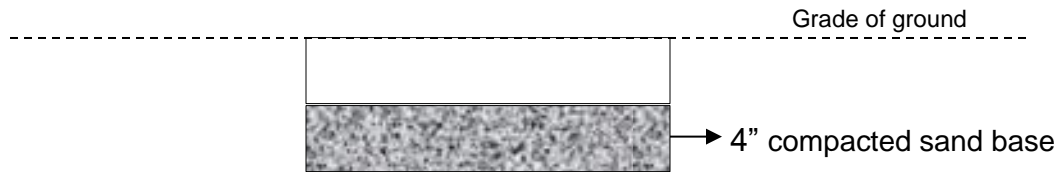

- ii. Flat granite monuments with a foundation – Granite dies shall be a minimum of 4" thick and be secured upon a minimum 4" deep foundation with a monument glue. Foundations must be installed flush with the grade of the ground and protrude 4" from all sides of the base.

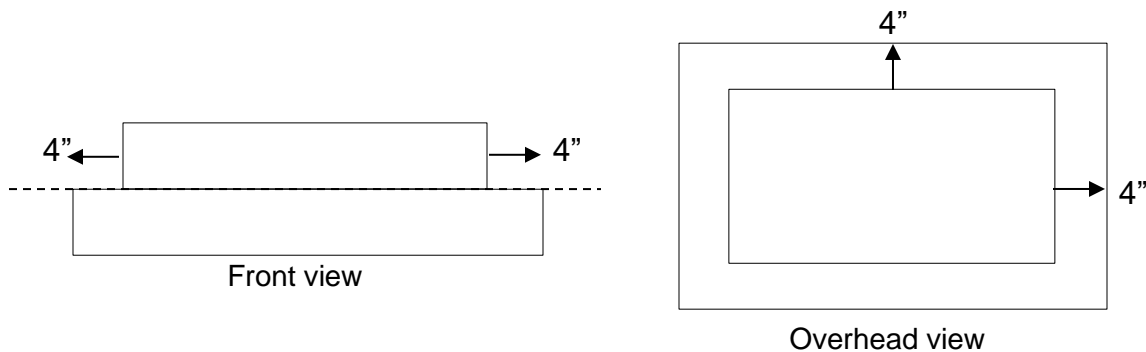

(c) Pillow Monuments

- i. Pillow monuments – Pillow dies shall be secured upon on a minimum 4” thick foundation with a monument glue. Pillow monuments may include a base but it is not required. If a pillow marker has a base then the base must be secured upon the foundation with monument glue and the pillow die being secured to the base in the same manner. Foundations must be installed flush with the grade of the ground and protrude 4” from all sides of the base.

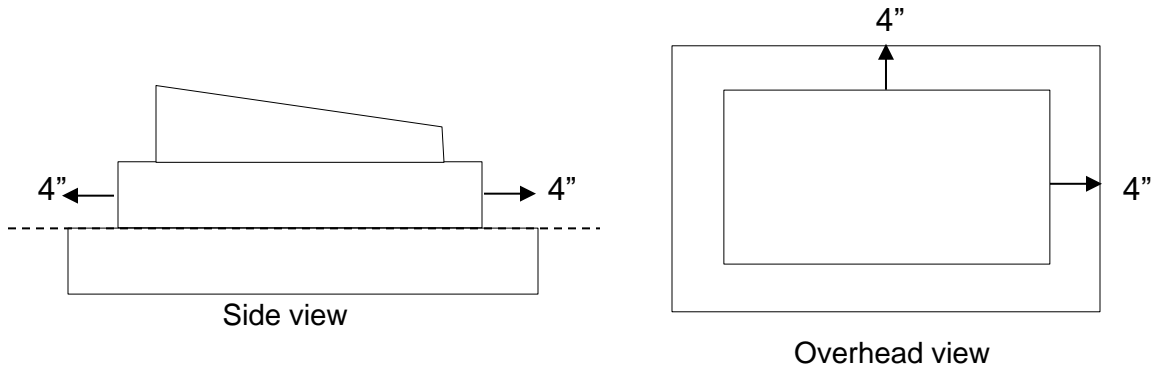

- ii. The base of pillow markers shall be between 12” and 16” in width, and 16” and 40” in length.

5. **Common Plot Markers**

- (a) A permit may be granted for the installation of a monument on a Common Plot provided that the plot has no previous monument.
- (b) The client will be responsible for paying the Indigent Fee, which is fifteen percent of the current plot license fee, as well as the Monument Permit Fee as set out in these Regulations.
- (c) The client will also be responsible for choosing the type, style, and size of the monument; however the monument must meet all specification and provide equal space for the names of all individuals interred within the said Common Plot.

6. Foot Markers

- i. Granite foot markers - have a maximum size of 12" by 24" and must be installed flush with the grade of the ground. Granite dies shall be 4" thick. If they are less than 4" in thickness then they are recommended to be encased in concrete to make the monument stronger. The City is not responsible for any damages that may incur to a monument that is less than the recommended thickness, this includes damage due to equipment or cemetery operations. No foundation is required.



- ii. Bronze foot markers - have a size maximum of 12" by 24" and must have a concrete or granite foundation. Foundations must protrude 2" from all sides of the monument with a size maximum of 16" by 28", and be installed flush with the grade of the ground.

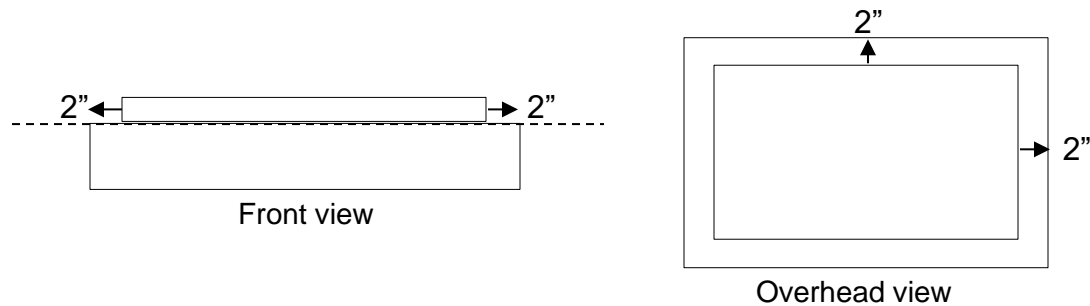

- (b) The City is not responsible for any failure or weakening of material used to secure a base or die.
- (c) Foundations shall be between 20" and 24" in width, and 24" and 48" in length for each lot unless otherwise stated, and a minimum of 4" in thickness. Foundations shall be made of 4" thick precast concrete or granite, or poured in place concrete with a minimum thickness of 6". All foundations must be installed flush with the grade of the ground.
- (d) The Cemetery Foreman must be contacted to inspect all monuments including the base and foundation, BEFORE the monument is placed. Failure to have the Cemetery Foreman make this inspection could result in removal of the monument to allow an inspection to be made, and in such cases, re-installation of the monument shall be the responsibility of the owner or contractor. The Foreman can be contacted by calling 306-953-4885.

7. Children's Monuments (Upright and Flat)

(a) Single piece upright children's monuments (no base) – The die may be secured upon a minimum 4" deep foundation with a monument glue; or be recessed 4" or more into the foundation with the foundation being a minimum of 6" deep.

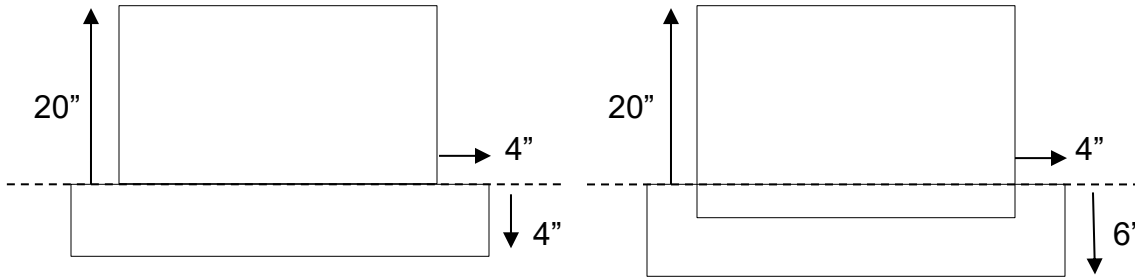

(b) Two-piece upright children's monuments - The base may be recessed 2" into a minimum 4" foundation; or secured upon the foundation with monument glue. Foundations must be installed flush with the grade of the ground and protrude 4" from all sides of the base.

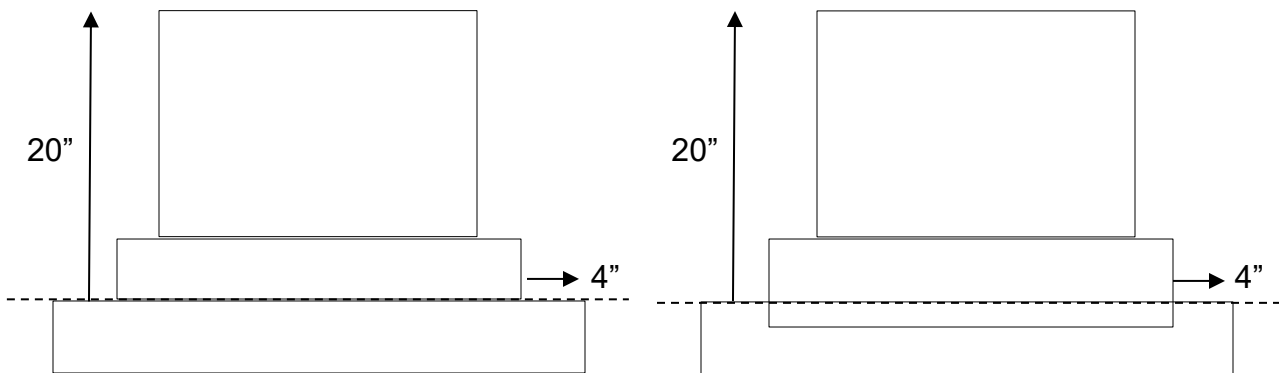

(c) Flat granite children's monuments installed flush with the grade of the ground - Shall be a minimum of 4" thick and be between 16" and 20" in width, and 24" and 36" in length. Flat flush monuments must be installed on 4" compacted sand base.

(d) Flat granite, bronze, & pillow children's monuments with a foundation will be subject to the monument regulations laid out above under Section 4(a), (b), & (c). The only difference would be the foundation size allowances for these plots as stated below:

- i. Foundations for children's monuments shall be 20" in width, and between 24" and 36" in length for each lot, unless otherwise stated, and a minimum of 4" in thickness. Foundations shall be made of 4" thick precast concrete or granite, or poured in place concrete with a minimum thickness of 6". All foundations must be installed flush with the grade of the ground. All children's monuments have a maximum height of 20" measured from the top of the foundation to the top of the monument.

- (e) The City is not responsible for any failure or weakening of material used to secure a base or die.
- (f) The base of upright children's monuments shall be 12" in width, and between 16" and 28" in length.
- (g) The Cemetery Foreman must be contacted to inspect all monuments including the base and foundation, BEFORE the monument is placed. Failure to have the Cemetery Foreman make this inspection could result in removal of the monument to allow an inspection to be made, and in such cases, re-installation of the monument shall be the responsibility of the owner or contractor. The Foreman can be contacted by calling 306-953-4885.

8. Columbaria Niche

- (a) Niches are 12"x12"x12" inside with an 11"x11" opening at the door.
- (b) All granite plates are provided by the City of Prince Albert; however, any engraving is the responsibility of the Licensee and will be done by a private contractor at their cost. Monument Permits are not required for these engravings.
- (c) To ensure consistency within the Columbaria, the following specifications for engraving must be used:
 - i. **Font** - Modified Roman
 - Family Name** – 1 ½" high (.75" high when there are two names)
 - First Name and Initial** – 1" high (.75" high when there are two names)
 - Dates** - 1" high (.75" high when there are two names)
 - ii. A ¾" blank border around all four sides of the granite door panel must be maintained.
 - iii. All **flat** picture engravings/etchings are allowed within the ¾" border. Any object that sticks out from the door (vases, candleholders, etc.) are prohibited.

9. Veteran's Monuments

- (a) All veteran's monuments are a standard size of 1'-3" x 3'-0" x 3'-3"
- (b) All monuments are contracted out through a private supplier by the City of Prince Albert, with the exception of any veteran's monument being funded and ordered by Veteran's Affairs or Last Post Fund.
- (c) The City will order the making of the monument through their supplier; however, the details and veteran information being inscribed on the monument will be at the sole decision of the deceased's next of kin or legal decision maker.
- (d) The Veteran's Section(s) have a poured in place concrete footing provided by the City, and the monument installation will be undertaken by the Cemetery Foreman.
- (e) Monument Permits are included in the License Fee and completed by the City with the exception of monuments being funded and ordered by Veteran's Affairs or Last Post Fund.
- (f) The City reserves the right to remove any monument in the Veteran Sections not conforming to the predetermined material, color and size.
- (g) The material and color for all monuments and markers in the Veteran Sections shall be grey granite with a steeled finish; similar grey granite may be used only with the approval of the Cemetery Foreman.
- (h) No vases or attachments of any kind shall be approved as an addition to, or as part of, any Monument in the Veteran sections.
- (i) Foot markers are not permitted in the Veteran Sections.
- (j) Spouses of Veteran's that are interred within the same plot can be memorialized in one of the following two ways:
 - i. Directly on the existing veteran's monument if space has been provided to accommodate another name and date engraving.
 - ii. On a bronze plaque that is to be adhered to the existing footing at the base of the veteran's monument. Maximum plaque size is 8"x14".